

RX³ MCB 4500 A
Phase + Neutral, neutral on left side
Cat. N°(s): 4199 46 ; 4199 47 ; 4199 49 ; 4199 50 ; 4199 51 ; 4199 52

CONTENTS
PAGE

1. Description, use	1
2. Range	1
3. Overall dimensions	1
4. Preparation - Connection	1
5. General characteristics	2
6. Compliance and approvals	6
7. Curves	7
8. Auxiliaries and accessories	10

1. DESCRIPTION - USE

Thermal-magnetic circuit breaker (MCB) with positive contact indication for control, protection against short-circuits and overloads, and isolation of electrical circuits.

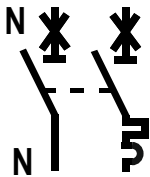
Symbol:

Technology:

- . Limiting device
- . The Neutral contact closes before and opens after the Phase contact
- . The Phase pole provides protection and isolation for the Phase circuit
- . The neutral pole provides isolation for the Neutral circuit

2. RANGE
Polarity:

- . 2 poles including 1 protected pole and 1 neutral pole

Width:

- . 1 module (17.8 mm)

Rated currents I_n:

- . 6 / 10 / 16 / 20 / 25 / 32 A ,

Magnetic tripping curves:

- . C curve (between 5 and 10 I_n)

Thermal tripping threshold

Thermal threshold in accordance with IEC/EN 60898-1

Rated voltage and frequency:

- . 230 V ~, 50/60 Hz with standard tolerances

Breaking capacity:

- . I_{cn} = 4500 A in accordance with standard IEC / EN 60898-1, energy limiting class : 3

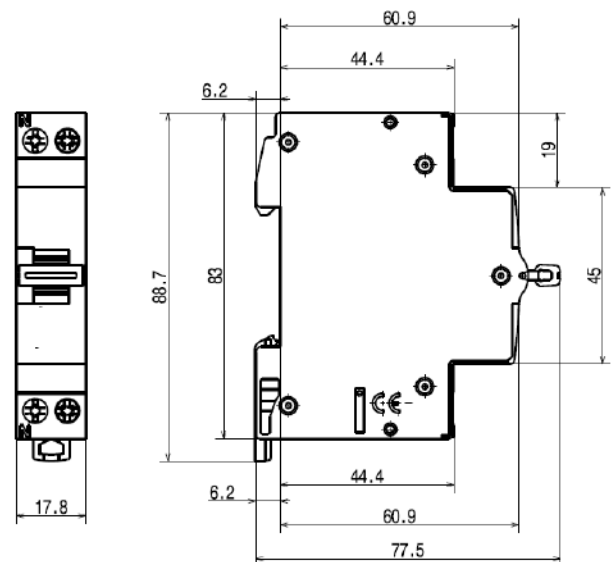
3. OVERALL DIMENSIONS

4. PREPARATION - CONNECTION
Mounting:

- . On symmetrical EN 60.715 rail or DIN 35 rail

Operating position:

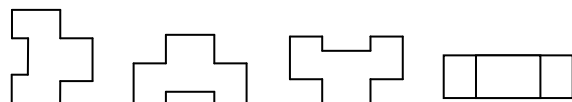
- . Vertical Horizontal Upside down On the side

Power supply:

- . Either from the top or the bottom

4. PREPARATION - CONNECTION *(continued)*

Connection:

- . Terminals protected against direct contact IP20, wired device
- . Cage terminals, with release and captive screws
- . Terminals fitted with shutters preventing a cable being placed under the terminal, with the terminal partly open or closed
- . Alignment and spacing of the terminals permitting connection with the other products in the range via prong supply busbars
- Terminal depth: 14 mm at the top and 13 mm at the bottom
- . Screw head: mixed, slotted and Pozidriv no. 2
- . Stripping length of wire : 12mm
- . Tightening torques:
 - Recommended: 1.6 to 2 Nm
 - Min.: 1.2 Nm
 - Max.: 2.8 Nm

Conductor type:

- . Copper cable or supply busbar
- . Cable cross-section

	Without ferrule	With ferrule
Rigid cable	1 x 0.75 to 16 mm ² 2 x 0.75 to 6 mm ²	-
Flexible cable	1 x 0.75 to 10 mm ² 2 x 0.75 to 4 mm ²	1 x 0.75 to 10 mm ²

- . Prong busbar, alone or with a flexible wire (without ferrule) 10 mm² or a connection terminal in the same terminal.

Recommended tools:

- . For the terminals, screwdriver with 5.5 mm blade or Pozidriv no. 2 screwdriver
- . For attaching or removing the DIN rail, screwdriver with 5.5 mm blade or Pozidriv no. 2 screwdriver

Manual actuation of the MCB:

- . Ergonomic 2-positions handle
- . "O-OFF": Device open
- . "I-ON": Device closed

Contact status display:

- . By the handle
- "O-OFF" = contacts open
- "I-ON" = contacts closed

Locking:

- . Padlocks possible in the open and closed positions with padlock support (Cat. No. 4 063 03) and Ø5 mm padlock (Cat. No. 4 063 13) or Ø6 mm padlock (Cat. No. 0 227 97)

Sealing:

- . Possible in the open or closed positions

5. GENERAL CHARACTERISTICS

Neutral earthing system:

- . IT, TT, TN

Marking on the front side:

- . By permanent ink pad printing

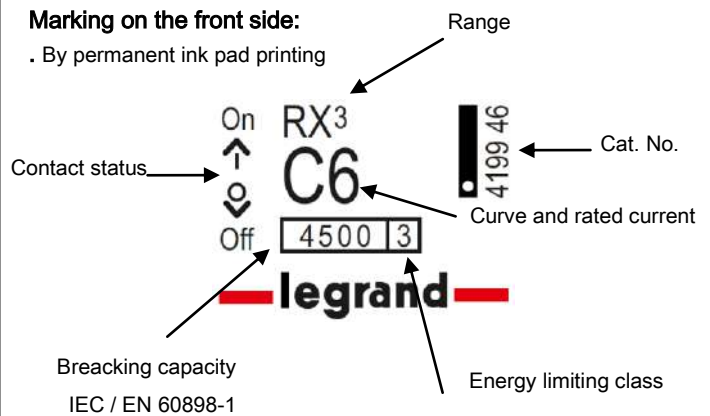

Marking on the upper panel:

- . By permanent ink pad printing

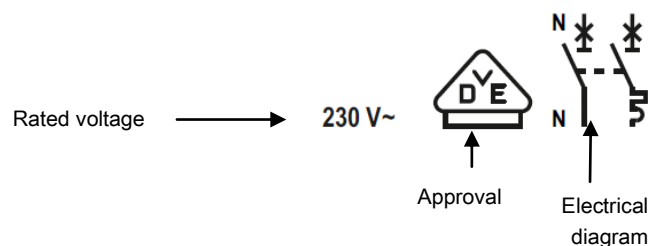

- . The terminals upstream and downstream of the neutral pole are marked with an "N" moulded close to the screw heads.

Lateral marking

- . By ink jet

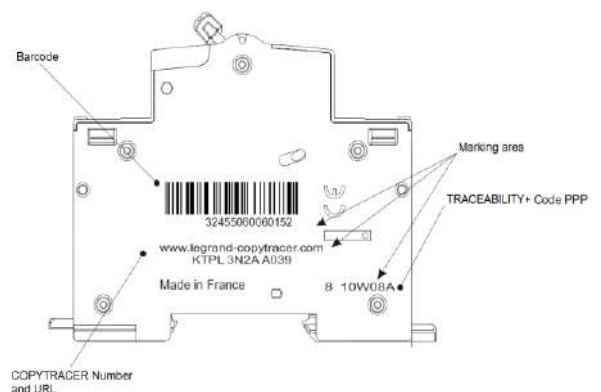

Minimum operating voltage:

- . U = 12 V AC

Maximum operating voltage:

- . U = 250 V / 50/60 Hz

5. GENERAL CHARACTERISTICS *(continued)*

Breaking capacity on one single pole (phase pole):

. In accordance with Icn1 IEC / EN 60898-1: 4.5 kA at 230 V ~

Breaking capacity:

Standard	Breaking capacity	Voltage between poles	Breaking capacity
IEC / EN 60898-1	Ics	230 V	4.5 kA
	Icn		4.5 kA

Energy limiting class : 3

Isolation distance:

. The distance between the contacts is greater than 5.5 mm with the handle in the open position.
 . The MCB is suitable for isolation in accordance with standard IEC / EN 60898-1.

Insulation voltage:

. Ui = 250 V in accordance with IEC /EN 60898-1

Degree of pollution:

. 2 in accordance with IEC /EN 60898-1

Dielectric strength:

. 2,000 V

Rated impulse withstand voltage:

. Uimp = 4 kV

Degree or class of protection:

. Terminals protected against direct contact. Class of protection against solid objects and liquids (wired device): IP20 in accordance with standards IEC60 529 – EN 60529 and NF 20-010
 . Front panel protected against direct contact: IP40
 . Class II in relation to metallic conductive parts
 . Class of protection against mechanical impacts IK04 in accordance with standard EN 62262.

Plastic materials:

. Polyamide , P.B.T. and P.C.

Enclosure heat and fire resistance:

. Resistance to glow wire tests at 960°C, in accordance with standard EN/IEC 60898-1
 . Classification V2, in accordance with UL94

Higher heating potential:

. The heat potential is assessed at: 1.32 MJ

Closing and opening force via the handle:

. 2 N on opening
 . 9 N on closing

Mechanical endurance:

. Compliant with IEC / EN 60898-1
 . Resist with 20,000 operations with no load

Electrical endurance:

. Compliant with standard IEC / EN 60898-1
 . Resist with 10,000 operations with load (In x Cos φ 0.9)

Sinusoidal vibration resistance in accordance with IEC 60068.2.6:

. Axes: x – y – z
 . Frequency: 10 to 55 Hz
 . Acceleration: 3g (1g = 9.81m.s⁻²)

Resistance to tremors:

. In accordance with standard IEC / EN 60898-1

Ambient temperatures:

. Operation: from - 25°C to + 70°C
 . Storage: from - 40°C to + 70°C

Packaged volume:

Packaging	Volume (dm ³)
Per 10	1.62

Average unit weight per catalogue number:

. 0.11 kg

5. GENERAL CHARACTERISTICS *(continued)*

Derating of MCBs function of the number of devices placed side by side:

When several MCBs are installed side by side and operate simultaneously, the heat dissipation of one pole is limited. This results in an increased operating temperature for the circuit breakers which may cause false tripping. Applying the following coefficients to the operating currents is recommended.

Number of MCBs side by side	Coefficient
2 - 3	0.9
4 - 5	0.8
6 - 9	0.7
≥ 10	0.6

These values are given in the IEC 61439-1 recommendation

In order to avoid having to use these coefficients there must be good ventilation and the devices must be kept apart using the spacing elements Cat. No. 4 063 07 (0.5 module).

Derating of MCBs in the event of use with fluorescent tubes:

Electronic or ferromagnetic ballasts provide a high inrush current for a very short time. These currents are liable to cause tripping of the circuit breakers.

The maximum number of ballasts per MCB stated by the lamp and ballast manufacturers in their catalogues should be taken into account during installation.

Impact of height:

	≤2,000 m	3,000 m	4,000 m	5,000 m
Dielectric strength	2,000 V	1,750 V	1,500 V	1,250 V
Maximum operating voltage	230 V	230 V	230 V	230 V
Derating at 30°C	none	none	none	none

Power dissipated in W for the phase pole in In:

. MCBs in In/Un

Rated current	6 A	10 A	16 A	20 A	25 A	32 A
Power (W) Phase pole	2.5	1.6	3.3	4	4.2	3.3
Power (W) Neutral pole	0.1	0.3	1.1	1.2	1.1	1.6

5. GENERAL CHARACTERISTICS *(continued)*

Derating of MCBs depending on the ambient temperature:

. The nominal characteristics of a circuit breaker are modified depending on the ambient temperature which prevails in the cabinet or enclosure where the MCBs is located.

. Reference temperature: 30°C in accordance with standard EN/IEC 60898-1.

In (A)	-25°C	-10°C	0°C	10°C	20°C	30°C	40°C	50°C	60°C	70°C
6	7.5	7.2	6.9	6.6	6.3	6	5.7	5.4	5.1	4.8
10	12.5	12	11.5	11	10.5	10	9.5	9	8.5	8
16	20	19.2	18.4	17.6	16.8	16	15.2	14.4	13.6	12.8
20	25	24	23	22	21	20	19	18	17	16
25	31.25	30	28.7	27.5	26.2	25	23.7	22.5	21.2	20
32	40	38.4	36.8	35.2	33.6	32	30.4	28.8	27.2	25.6

6. COMPLIANCE AND APPROVALS**In accordance with standards:**

- . EN/IEC 60898-1

Usage in special conditions:

- . Category C compliant (testing temperature range from -25°C to +70°C, resistant to salt spray) in accordance with the classification defined in Appendix Q of standard IEC/EN 60947-1

Respect for the environment – Compliance with European Union Directives:

- . Compliance with Directive 2002/95/EC of 27/01/03 known as "RoHS" which provides for a restriction on the use of dangerous substances such as lead, mercury, cadmium, hexavalent chromium and polybrominated biphenyl (PBB) and polybrominated diphenyl ether (PBDE) brominated flame retardants from 1st July 2006
- . Compliance with the Directive 91/338/EEC of 18/06/91 and decree 94-647 of 27/07/04

Plastic materials:

- . Halogen free plastic materials.
- . Labelling of parts compliant with ISO 11469 and ISO 1043.

Packaging:

- . Design and manufacture of packaging compliant with decree 98-638 of 20/07/98 and Directive 94/62/EC

Approvals obtained:

- . Germany : VDE

Precious material

- . Silver

7. CURVES

Thermal-magnetic tripping curve range typical of C curve MCBs:

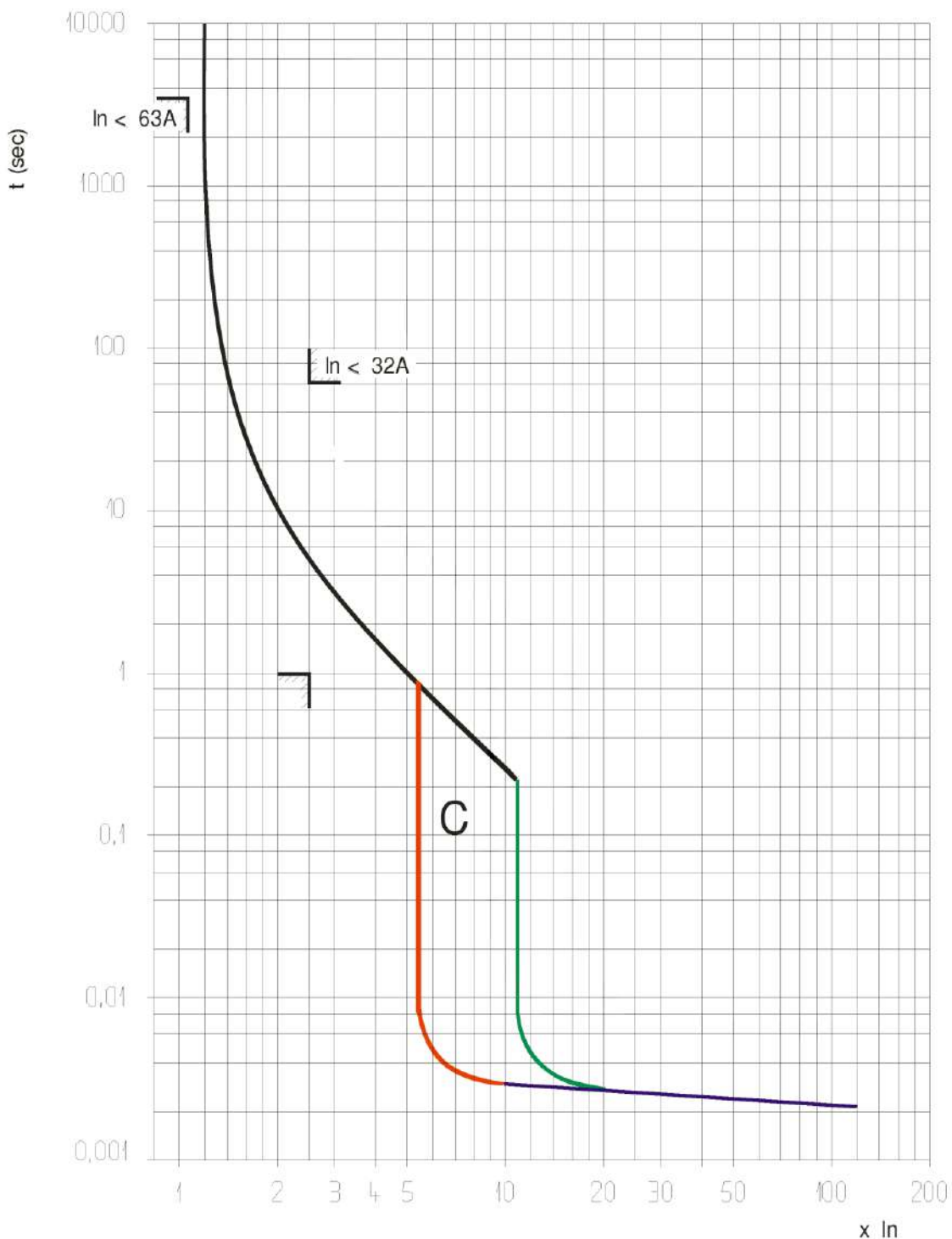

7. CURVES (continued)

Average thermal-magnetic tripping curves range typical of C curve MCBs:

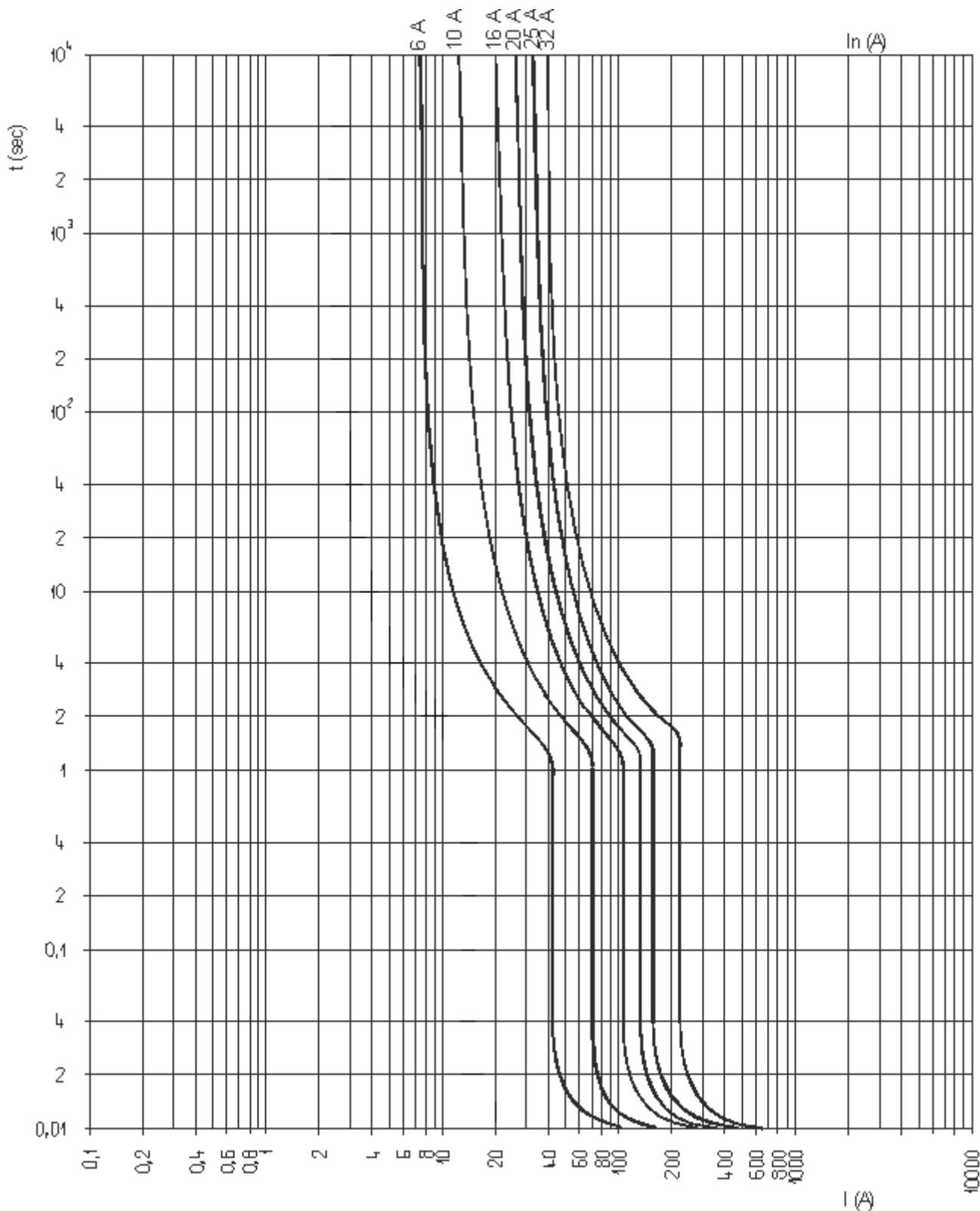

7. CURVES (continued)

Thermal stress limiting curves :

. C curve MCBs

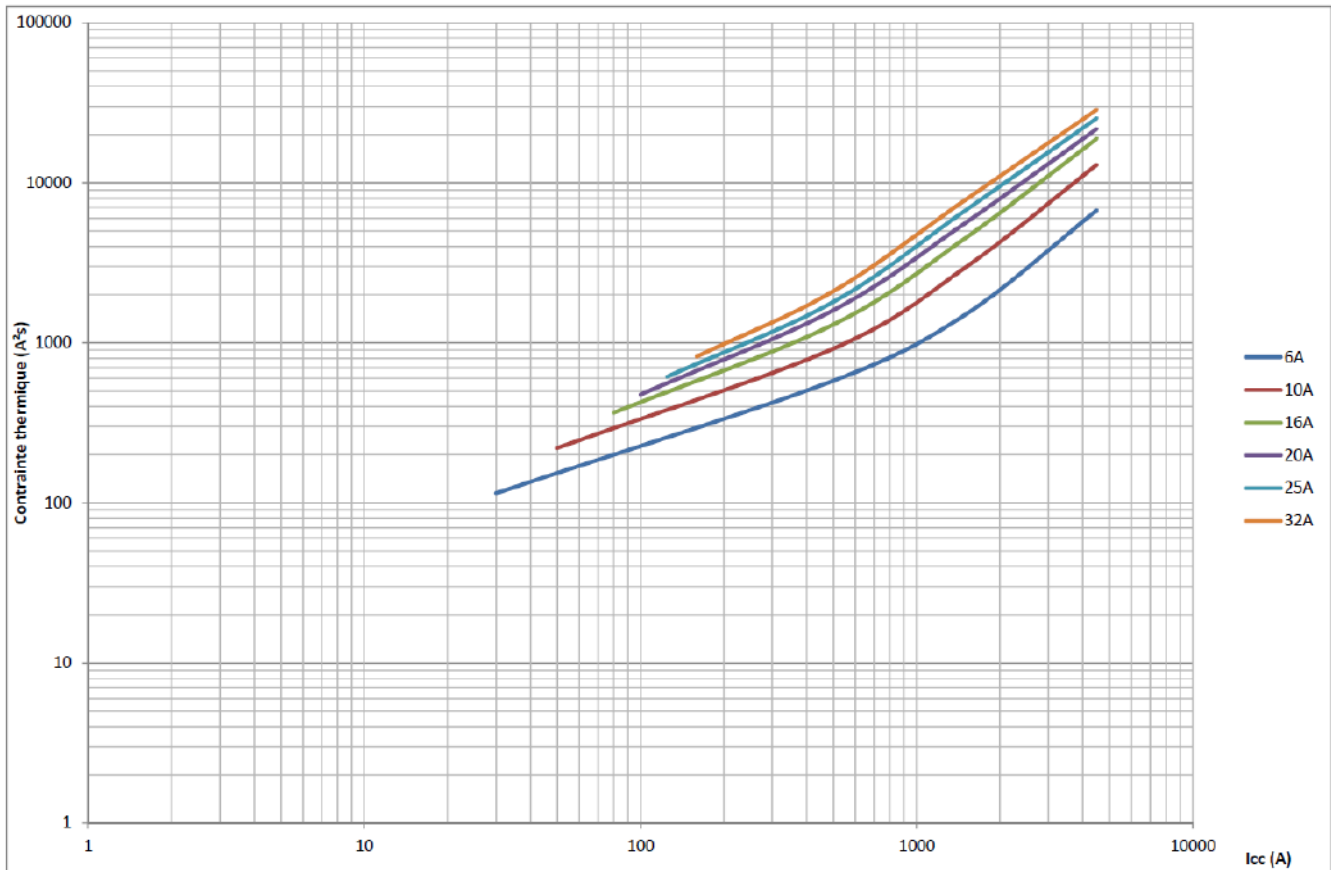

I_{cc} = prospective short-circuit symmetrical current (rms value in A)

Limited thermal stress (in A²s)

8. AUXILIARIES AND ACCESSORIES

Wiring accessories:

- . Supply busbar HX³ single-pole universal supply busbar (Cat. No. 4 049 26, 28, 37)
- . Connection terminals (cat. No. 4 049 05)
- . Sealable screwcover (cat. No. 4 063 04)

Sealing:

- . Possible in the open or closed positions

Locking options:

- . Via padlock 5 mm in diameter (Cat. No. 4 063 13) or padlock 6 mm in diameter (Cat. No. 0 227 97) and padlock support (Cat. No. 4 063 03)